

Dell PowerVault MD3260 Series Storage Arrays Deployment Guide



Notes, Cautions, and Warnings



NOTE: A NOTE indicates important information that helps you make better use of your computer.



CAUTION: A CAUTION indicates either potential damage to hardware or loss of data and tells you how to avoid the problem.



WARNING: A WARNING indicates a potential for property damage, personal injury, or death.

© 2013 Dell Inc. All Rights Reserved.

Trademarks used in this text: Dell™, the Dell logo, Dell Boomi™, Dell Precision™, OptiPlex™, Latitude™, PowerEdge™, PowerVault™, PowerConnect™, OpenManage™, EqualLogic™, Compellent™, KACE™, FlexAddress™, Force10™, Venue™ and Vostro™ are trademarks of Dell Inc. Intel®, Pentium®, Xeon®, Core® and Celeron® are registered trademarks of Intel Corporation in the U.S. and other countries. AMD® is a registered trademark and AMD Opteron™, AMD Phenom™ and AMD Sempron™ are trademarks of Advanced Micro Devices, Inc. Microsoft®, Windows®, Windows Server®, Internet Explorer®, MS-DOS®, Windows Vista® and Active Directory® are either trademarks or registered trademarks of Microsoft Corporation in the United States and/or other countries. Red Hat® and Red Hat® Enterprise Linux® are registered trademarks of Red Hat, Inc. in the United States and/or other countries. Novell® and SUSE® are registered trademarks of Novell Inc. in the United States and other countries. Oracle® is a registered trademark of Oracle Corporation and/or its affiliates. Citrix®, Xen®, XenServer® and XenMotion® are either registered trademarks or trademarks of Citrix Systems, Inc. in the United States and/or other countries. VMware®, vMotion®, vCenter®, vCenter SRM™ and vSphere® are registered trademarks or trademarks of VMware, Inc. in the United States or other countries. IBM® is a registered trademark of International Business Machines Corporation.

2013 - 09

Rev. A01

Contents

1 Introduction.....	5
System Requirements.....	5
Management Station Requirements.....	5
Introduction To Storage Arrays.....	5
2 Hardware Installation.....	7
Planning The Storage Configuration	7
Connecting The Storage Array	7
Cabling The Storage Array.....	7
Redundant And Non-Redundant Configurations.....	8
Dual Controller Configurations.....	8
Cabling PowerVault MD3060e Expansion Enclosures.....	13
Expanding With New PowerVault MD3060e Expansion Enclosures.....	13
3 Installing MD Storage Manager.....	15
Installing Host Bus Adapters And Drivers.....	15
Graphical Installation (Recommended).....	16
Console Installation	17
Silent Installation	17
Silent Installation On Windows.....	17
Silent Installation On Linux.....	17
Upgrading PowerVault MD Storage Manager.....	17
4 Post Installation Tasks.....	19
Verifying Storage Array Discovery.....	19
Initial Setup Tasks.....	20
5 Uninstalling MD Storage Manager.....	21
Uninstalling MD Storage Manager From Windows.....	21
Uninstall MD Storage Manager From Microsoft Windows Operating Systems Other Than Microsoft Windows Server 2008.....	21
Uninstall MD Storage Manager From Windows Server 2008 GUI Versions.....	21
Uninstall MD Storage Manager From Windows Server 2008 Core Versions.....	21
Uninstalling MD Storage Manager From Linux.....	22
6 Appendix — Load Balancing.....	23
Windows Load Balance Policy.....	23
Round Robin With Subset.....	23

Changing Load Balance Policies In Windows Sever 2008	23
Least Queue Depth With Subset.....	23
Changing The Load Balance Policy Using Windows Server 2008 Device Manager Options.....	24
Changing The Load Balance Policy Using The Windows Server 2008 Disk Management Options.....	24
Setting Load Balance Policies in Linux.....	24

Introduction

This guide provides information about deploying Dell PowerVault MD3260 storage arrays. The deployment process includes:

- Hardware installation
- Modular Disk Storage Manager (MD Storage Manager) installation
- Initial system configuration

Other information provided include system requirements, storage array organization, and utilities.

 **NOTE:** For more information on product documentation, see support.dell.com/manuals.

MD Storage Manager enables an administrator to configure and monitor storage arrays for optimum usability. The version of MD Storage Manager included on the PowerVault MD Series resource media can be used to manage both the PowerVault MD3260 Series and other PowerVault MD Series storage arrays. MD Storage Manager is compatible with both Microsoft Windows and Linux operating systems.

System Requirements

Before installing and configuring the PowerVault MD3260 Series hardware and software, ensure that the supported operating system is installed and minimum system requirements are met. For more information, see the Support Matrix at support.dell.com/manuals.

Management Station Requirements

A management station uses MD Storage Manager to configure and manage storage arrays across the network. A management station must meet the following minimum system requirements:

- Intel Pentium or an equivalent processor (1333 MHz or faster) with 512 MB RAM (1024 MB recommended).
- 1 GB disk space.
- Display resolution of 1024x768 with 16 million colors (1280x1024 32-bit recommended).
- Microsoft Windows, Red Hat Enterprise Linux, or SUSE Linux Enterprise Server.

 **NOTE:** Operating system installations can be either native or hypervisor guest configurations.

 **NOTE:** Supported hypervisors include Microsoft Hyper-V, Citrix XenServer, and VMware. For information about the supported versions, see the Support Matrix at support.dell.com/manuals.

- Administrator or equivalent permissions.

Introduction To Storage Arrays

An enclosure containing physical disks accessed through RAID controller modules is called a storage array. A storage array includes various hardware components, such as physical disks, RAID controller modules, fans, and power supplies.

One or more host servers attached to the storage array can access the data on the storage array. You can also establish multiple physical paths between the host(s) and the storage array so that loss of any single path (for example, through failure of a host server port) does not result in loss of access to data on the storage array.

The storage array is managed by MD Storage Manager running on a:

- Host server — On a host server system, MD Storage Manager and the storage array communicate management requests and event information using SAS connections.
- Management station — On a management station, MD Storage Manager communicates with the storage array either through an Ethernet connection to the storage array management port or through an Ethernet connection to a host server. The Ethernet connection passes management information between the management station and the storage array using SAS connections.

Using MD Storage Manager, you can configure the physical disks in the storage array into logical components called disk groups and then divide the disk groups into virtual disks. Disk groups are created in the unconfigured capacity of a storage array. Virtual disks are created in the free capacity of a disk group.

Unconfigured capacity comprises physical disks not already assigned to a disk group. When a virtual disk is created using unconfigured capacity, a disk group is automatically created. If the only virtual disk in a disk group is deleted, the disk group is also deleted. Free capacity is space in a disk group that is not assigned to any virtual disk.

Data is written to the physical disks in the storage array using RAID technology. RAID levels define the way in which data is written to physical disks. Different RAID levels offer different levels of accessibility, redundancy, and capacity. You can set a specified RAID level for each disk group and virtual disk on your storage array. For more information about using RAID and managing data in your storage solution, see the Administrator's Guide at support.dell.com/manuals.

Hardware Installation

Before using this guide, ensure that you review the instructions in the:

- *Getting Started Guide*— The *Getting Started Guide* that shipped with the storage array, provides information to configure the initial setup of the system.
- *Dell PowerVault MD3260/3260i/3660i/3660f/3060e Storage Arrays Administrator's Guide*— The Administrator's Guide provides information about important concepts you must know before setting up your storage solution. See the Administrator's Guide at support.dell.com/manuals.
- The Rack Installation instructions, that shipped with the storage array, provides information on how to rack your system.

Planning The Storage Configuration

Consider the following before installing your storage array:

- Evaluate data storage needs and administrative requirements.
- Calculate availability requirements.
- Decide the frequency and level of backups, such as weekly full backups with daily partial backups.
- Consider storage array options, such as password protection and e-mail alert notifications for error conditions.
- Design the configuration of virtual disks and disk groups according to a data organization plan. For example, use one virtual disk for inventory, a second for financial and tax information, and a third for customer information.
- Decide whether to allow space for hot spares, which automatically replace failed physical disks.

Connecting The Storage Array

The storage array is connected to a host using two hot-swappable RAID controller modules. The RAID controller modules are identified as RAID controller module 0 and RAID controller module 1.

Each RAID controller module has four FC IN (host) port connectors that provide FC connections to the host or node. Each RAID controller module also contains an Ethernet management port and a SAS OUT port connector. The Ethernet management port allows you to install a dedicated management station (server or stand-alone system). The SAS OUT port allows you to connect the storage array to optional expansion enclosures for additional storage capacity.

 **NOTE:** When you connect a host server to a storage array FC IN port connector, any OUT port connector of the host bus adapter (HBA) of the server can be used.

Cabling The Storage Array

You can cable the storage array to host servers with:

- Single path data configuration — A single path configuration allows you to connect a maximum of eight hosts. This is a non-redundant configuration.
- Dual path data configuration — A dual path configuration allows you to connect a maximum of four hosts.

You choose the data configuration based on:

- Number of hosts required
- Level of data redundancy required

Redundant And Non-Redundant Configurations

Non-redundant configurations are configurations that provide only a single data path from a host to the storage array. This type of configuration is only recommended for non-critical data storage. Path failure from a failed or removed cable, a failed HBA, or a failed or removed RAID controller module results in loss of host access to storage on the storage array.

Redundancy is established by installing separate data paths between the host and the storage array, in which each path is to one of the two RAID controller modules installed in the storage array. Redundancy protects the host from losing access to data in the event of path failure, because both RAID controller modules can access all the disks in the storage array.

Dual Controller Configurations

The following figures show two and four hosts, each connected to two RAID controller modules. Since each host has redundant paths, loss of a single path would still allow access to the storage array through the alternate path.

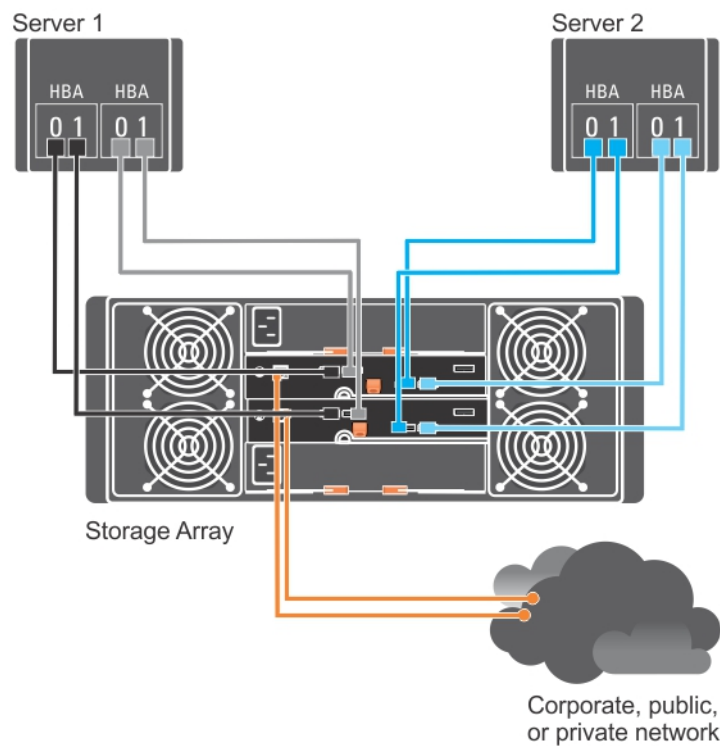

Figure 1. Two Hosts Connected to Two Controllers

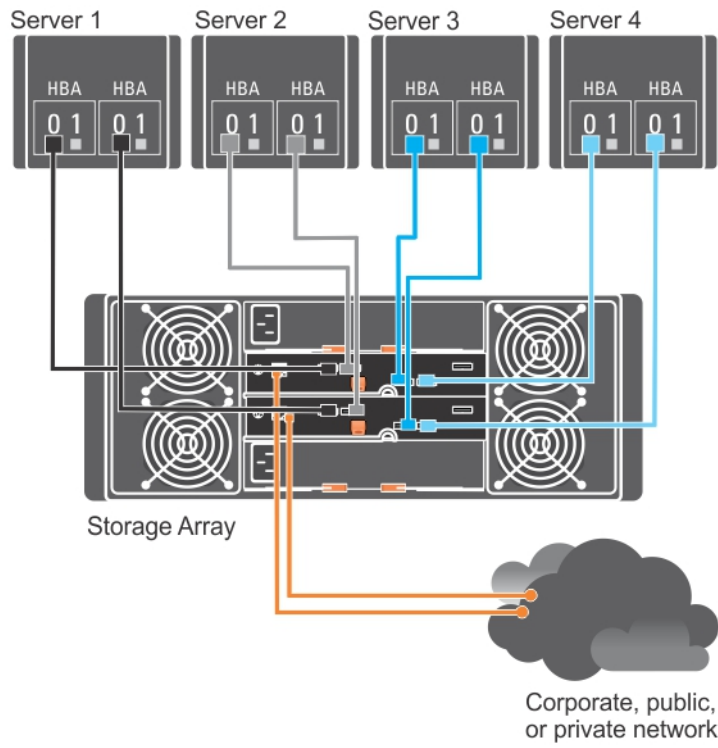

Figure 2. Four Hosts Connected to Two Controllers

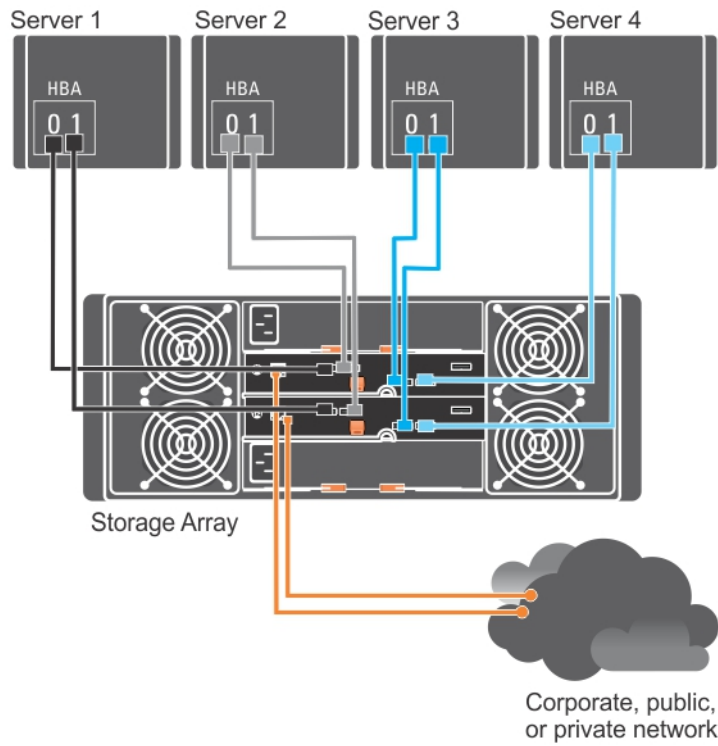

Figure 3. Four Hosts Connected to Two Controllers

The following figure shows eight hosts, each connected to only one RAID controller module. This configuration allows the maximum number of hosts that may be connected, but provides no redundancy.

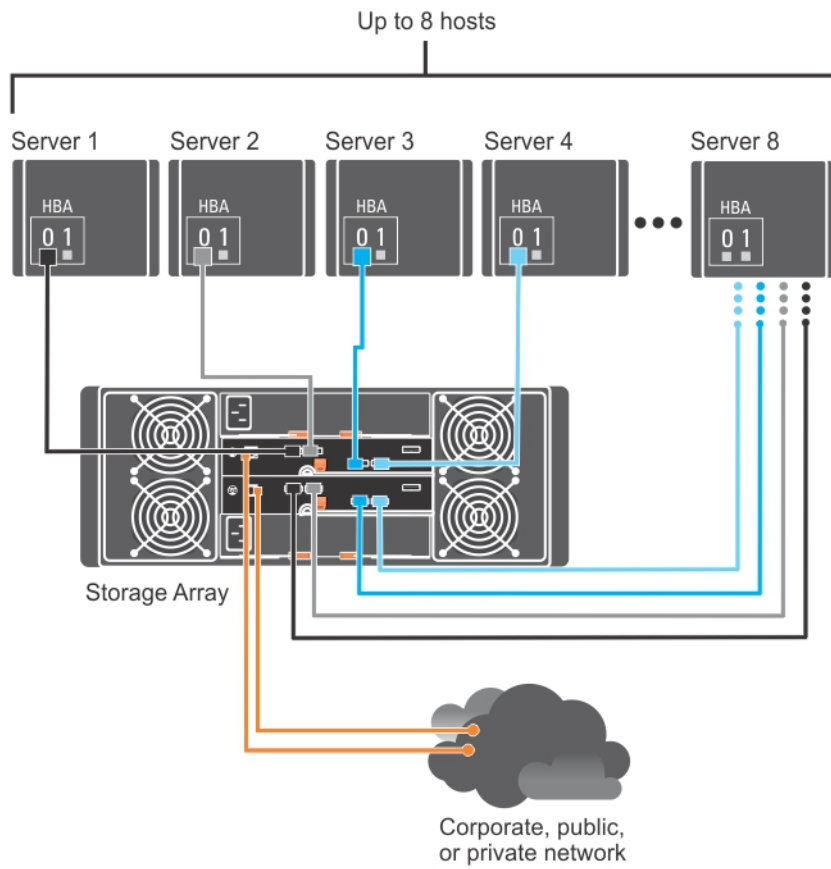

Figure 4. Eight Hosts Connected to Two Controllers

The following figures show up to four cluster nodes connected to two RAID controller modules. Since each cluster node has redundant paths, loss of a single path would still allow access to the storage array through the alternate path.

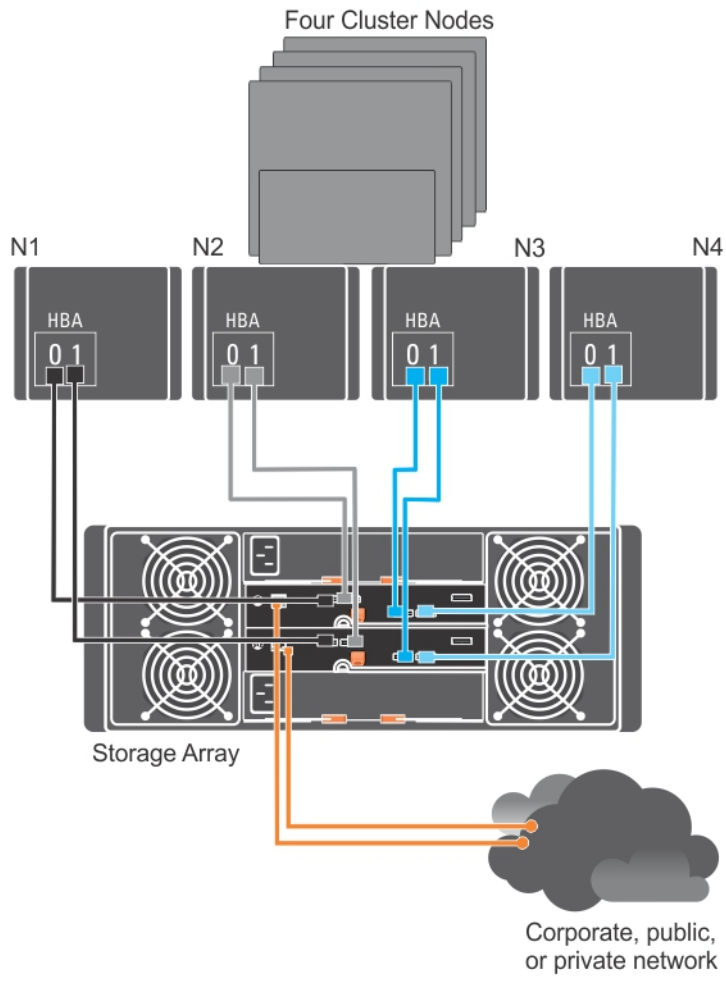

Figure 5. Four Cluster Nodes Connected to Two Controllers

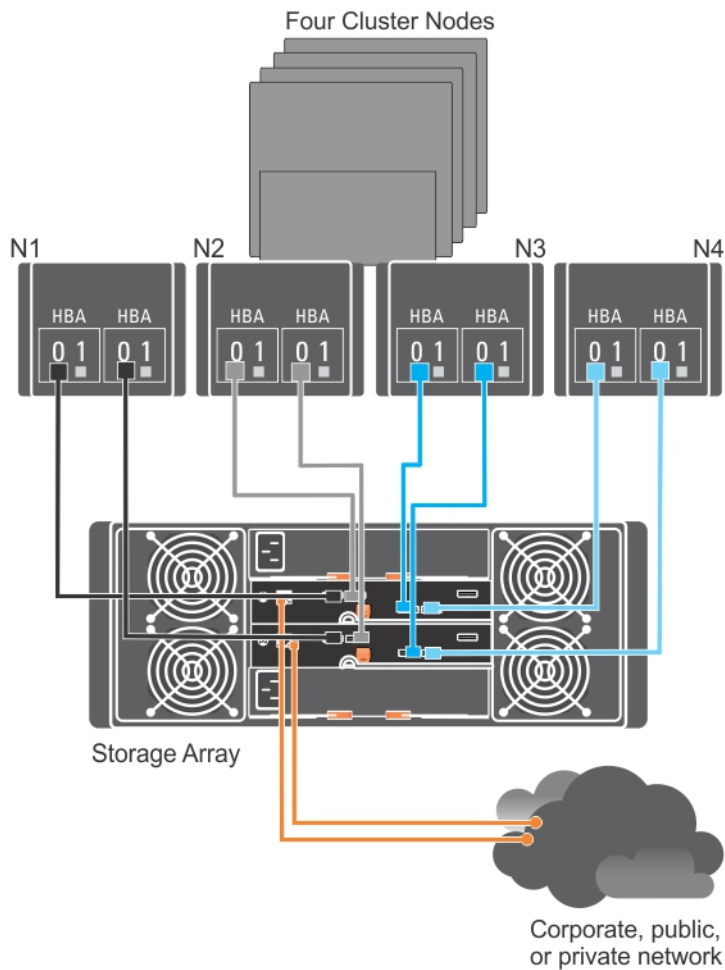

Figure 6. Four Cluster Nodes Connected to Two Controllers

Cabling PowerVault MD3060e Expansion Enclosures

You can expand the capacity of your PowerVault MD3260 Series storage array by adding PowerVault MD3060e expansion enclosures. You can expand the physical disk pool to a maximum of 120 (or 180, if enabled using Premium Feature activation) physical disks using a maximum of two expansion enclosures.

NOTE: Hot plug of MD3060e expansion enclosure is not recommended. Power on all MD3060e expansion enclosures before you power on the array enclosure. For helpful videos and other resources on PowerVault MD series, see dell.com/PVresources.

Expanding With New PowerVault MD3060e Expansion Enclosures

Perform the following steps to attach new PowerVault MD3060e expansion enclosures to a PowerVault MD3260 Series storage array:

1. Before adding the expansion enclosure(s), ensure that the storage array software is installed and is up to date.

For more information, see the Support Matrix at support.dell.com/manuals.

2. Install the software and driver package included on the PowerVault MD Series resource media.
For information about installing the software, see [Installing MD Storage Manager](#).
3. Using **MD Storage Manager**, update the RAID controller module and NVSRAM firmware to the latest versions available on support.dell.com.
4. Click **Tools** → **Upgrade RAID Controller Module Firmware** from the **Enterprise Management Window** (EMW).
5. Stop all I/O to the storage array and turn off affected host systems attached to the storage array.
6. Turn off the storage array.
7. Turn off any expansion enclosure(s) in the affected system.
8. Cable the expansion enclosure(s) to the storage array.
9. Turn on the expansion enclosure(s) and wait for the enclosure status LED to turn blue.
10. Turn on the storage array and wait for the status LED to indicate that the unit is ready:
 - When power is on, the power on indicator lights solid green.
 - If the Service action required indicator lights amber, there is an error that can be viewed using the PowerVault Modular Disk Storage Manager.
11. After the storage array is online and ready, turn on any attached host systems.
12. Using **PowerVault MD Storage Manager**, update all attached expansion enclosure firmware if it is out of date.
13. From the EMW, select the enclosure that you want to update and launch the **Array Management Window** (AMW).
14. Select **Upgrade** → **EMM Firmware**.
15. Click **Select All** to update all the attached expansion enclosures simultaneously.
16. Click **Start**.

Installing MD Storage Manager

The PowerVault MD Series resource media contains software and drivers for both Linux and Microsoft Windows operating systems.

The root of the media contains a **readme.txt** file covering changes to the software, updates, fixes, patches, and other important data applicable to both Linux and Windows operating systems. The **readme.txt** file also specifies requirements for accessing documentation, information regarding versions of the software on the media, and system requirements for running the software.

 **CAUTION:** Do not install MD Storage Manager exclusively on a virtual disk that is being actively managed by MD Storage Manager. Instead, install at least one instance of MD Storage Manager on a local disk that is running SMagent and SMmonitor. Installing management software only on a virtual disk may prevent access to recovery information in the event of multiple physical disk or enclosure failures.

For more information on supported hardware and software for Dell PowerVault systems, see the Support Matrix at dell.com/support/manuals.

 **NOTE:** As a first step towards managing the array, always use MD Storage Resource DVD media to update and install MD Storage Manager. For the latest updates and Support Matrix, see dell.com/support/manuals.

The PowerVault MD3260 Series storage firmware installer provides features that include the core software and providers. The core software feature includes the host-based storage agent, multipath driver, and MD Storage Manager application used to configure, manage and monitor the storage array solution. The providers feature include providers for the Microsoft Virtual Disk Service (VDS) and Microsoft Volume Shadow-Copy Service (VSS) framework.

 **NOTE:** For more information about the Microsoft VDS and Microsoft VSS providers, see the Administrator's Guide at dell.com/support/manuals.

 **NOTE:** To install the software on a Windows or Linux system, you must have administrative or root privileges.

 **NOTE:** If Dynamic Host Configuration Protocol (DHCP) is not used, initial configuration of the management station must be performed on the same physical subnet as the storage array. Additionally, during initial configuration, at least one network adapter must be configured on the same IP subnet as the storage array's default management port (192.168.128.101 or 192.168.128.102). After initial configuration, the management ports are configured using MD Storage Manager and the management station's IP address can be changed back to the previous settings.

The PowerVault MD Series resource media offers the following installation methods:

- Graphical Installation (Recommended) — This is the recommended installation procedure. The installer presents a graphical wizard-driven interface that allows customization of which components are installed.
- Console Installation — This installation procedure is useful for Linux users who do not desire to install an X-Window environment on their supported Linux platform.
- Silent Installation — This installation procedure is useful if you prefer to create scripted installations.





Installing Host Bus Adapters And Drivers

1. Install the host bus adapters (HBAs).
2. Connect the cables.

3. Install the HBA drivers and the operating system HBA patches or hotfixes.
4. Ensure that the recommended HBA settings are applied.

Graphical Installation (Recommended)

MD Storage Manager configures, manages, and monitors the storage array. To install the MD Storage Manager:

1. Insert the PowerVault MD Series resource media into your system or download the installer image from dell.com/support.
Depending on your operating system, the installer may launch automatically. If the installer does not launch automatically, navigate to the root directory of the installation media (or downloaded installer image) and run the **md_launcher.exe** file. For Linux-based systems, navigate to the root of the resource media and run the **autorun** file.
 **NOTE:** By default, Red Hat Enterprise Linux mounts the resource media with the **–noexec** mount option which does not allow you to run executable files. To change this setting, see the **Readme** file in the root directory of the resource media.
2. Select **Install MD Storage Software**.
3. Read and accept the license agreement.
4. Select one of the following installation options from the **Install Set** menu:
 - **Full (recommended)** — Installs the MD Storage Manager (client), host-based storage agent, multipath driver, and hardware providers.
 - **Host Only** — Installs the host-based storage agent and multipath drivers. See [Installing MD Storage Manager](#).
 - **Management** — Installs the management software and hardware providers.
 - **Custom** — Allows you to select specific components.
5. Select the PowerVault MD storage array model(s) you are setting up to serve as data storage for this host server.
6. Choose whether to start the event monitor service automatically when the host server reboots or manually.
 **NOTE:** This option is applicable only to Windows client software installation
7. Confirm the installation location and choose **Install**.
8. If prompted, reboot the host server once the installation completes.
9. Start **MD Storage Manager** and discover the array(s).
 **NOTE:** If Dynamic Host Configuration Protocol (DHCP) is not used on the network where the PowerVault MD storage array's management ports are connected, it is recommended that you enable IPv6 on the management station to discover the storage array(s).
 **NOTE:** If automatic discovery does not find the new array, use manual option and provide the default management ports IP addresses 192.168.128.100 and 192.168.128.102 using the same subnet or same VLAN for the MD Storage Manager management station.
10. If applicable, activate any premium features purchased with your storage array. If you purchased premium features, see the printed activation card shipped with your storage array.
 **NOTE:** The **MD Storage Manager** installer automatically installs the required drivers, firmware, and operating system patches/hotfixes to operate your storage array. These drivers and firmware are also available at dell.com/support. In addition, see the Support Matrix at dell.com/support/manuals for any additional settings and/or software required for your specific storage array.

Console Installation

 **NOTE:** Console installation only applies to Linux systems that are not running a graphical environment.

The autorun script in the root of the resource media detects when there is no graphical environment running and automatically starts the installer in a text-based mode. This mode provides the same options as graphical installation.

Silent Installation

Silent Installation On Windows

To run silent installation on a Windows system:

1. Copy the **custom_silent.properties** file in the **/windows** folder of the installation media or image to a writable location on the host server.
2. Modify the **custom_silent.properties** file to reflect the features, models and installation options to be used. Then, save the file.
3. After the **custom_silent.properties** file is revised to reflect your specific installation, run the following command to begin the silent installation:

```
mdss_install.exe -f <host_server_path>\ custom_silent.properties
```

Silent Installation On Linux

To run silent installation on a Linux system:

 **NOTE:** On Red Hat Enterprise Linux 6 operating systems, run the following script from the root directory to install prerequisite packages:

```
# md_prereq_install.sh
```

1. Copy the **custom_silent.properties** file in the **/windows** folder of the installation media or image to a writable location on the host server.
2. Modify the **custom_silent.properties** file to reflect the features, models and installation options to be used. Then, save the file.
3. After the **custom_silent.properties** file is revised, run the following command to begin the installation:

```
./mdss_install.bin -f <host_server_path>/custom_silent.properties
```

Upgrading PowerVault MD Storage Manager

To upgrade from a previous version of the PowerVault MD Storage Manager, uninstall the previous version (see [Uninstalling MD Storage Manager](#)), and then follow the instructions in [Installing MD Storage Manager](#) to install the new version.

Post Installation Tasks

Before using the Dell PowerVault storage array for the first time, complete these initial configuration tasks in the order shown. These tasks are performed using the MD Storage Manager.

1. For out-of-band management, you must set the network configuration for each RAID controller module, including its Internet Protocol (IP) address, subnetwork mask (subnet mask), and gateway.

 **NOTE:** You can set the network configuration using a DHCP server.

2. Launch **MD Storage Manager**.

- Click **Start** → **Programs** → **Dell** → **MD Storage Manager** → **Modular Disk Storage Manager Client** on Microsoft Windows operating systems.
- Click the **PowerVault MD Storage Manager** desktop icon on Linux operating systems.
- You can also launch **PowerVault MD Storage Manager** in Linux by running the following commands at the command prompt:

```
cd /opt/dell/mdstoragesoftware/mdstoragemanager/client./SMclient
```

3. Go to **Setup** → **Add Storage Array** and start the automatic discovery of systems in the **Enterprise Management Window (EMW)**.

 **NOTE:** Only storage arrays configured with IP address on the same subnet as the management stations will be detected.

 **NOTE:** It may take several minutes for the discovery process to complete. Closing the **Automatic Discovery Status** window before this stops the discovery process.

After discovery is complete, a confirmation screen is displayed.

4. Click **Close**.

Verifying Storage Array Discovery

The **Automatic Discovery** option automatically discovers both in-band and out-of-band arrays and adds the storage arrays to the management domain. If the out-of-band or in-band connections shown on the summary page are not accurate, complete the following steps. For more information, see the Online Help.

1. Check the hardware and connections for possible problems.
For specific procedures on troubleshooting interface problems, see the Owner's Manual at support.dell.com/manuals.
2. Verify that the array is on the local subnetwork. If it is not, using MD Storage Manager, manually add the storage array to the subnet.
3. Verify that the status of each storage array is **Optimal**.
4. If any array shows an **Unresponsive** status, complete one of the following steps:
 - To remove the array from the management domain, select the array, right-click and click **Remove** → **Storage Array**.
 - To add an array, in the EMW, select **Automatic Discovery**.

Initial Setup Tasks

1. The name of the first storage array found is displayed in the **Devices** tab of the EMW.
To see a list of all storage arrays found on the local network, expand **Discovered Storage Arrays** in the **Devices** tab of the EMW.
2. The default name for a newly installed MD3260 series storage array is *Unnamed*. If another name is displayed in MD Storage Manager, click the down arrow next to the name and click **Unnamed** in the drop-down list.
3. Double-click on the discovered array to launch the array management window and make changes to the configuration of the array.
4. Click **Perform Initial Setup Tasks** to see an outline and links to the remaining post-installation tasks.
The array is now ready to be configured. See the Administrator's Guide at support.dell.com/manuals for information about each task and to perform the necessary configuration steps. The following table lists the recommended configuration steps that can be accomplished in MD Storage Manager.

 **NOTE:** Before configuring the storage array, check the status icons on the **Device** pane to ensure that the enclosures in the storage array are in an **Optimal** status. For more information on the status icons, see the Owner's Manual at support.dell.com/manuals.

Task	Purpose
Rename the storage array	To provide a more meaningful name than the software-assigned label, Unnamed.
Set a storage array password	To restrict unauthorized access. MD Storage Manager may ask for a password before changing the configuration or performing a destructive operation.
Set up alert notifications Set up e-mail alerts Set up SNMP alerts	To notify individuals (by e-mail) and/or storage enterprise management consoles, such as Dell Management Console, (by SNMP) when a storage array component degrades or fails, or an adverse environmental condition occurs.
Configure a storage array	To create virtual disks and map them to hosts.

Uninstalling MD Storage Manager

Uninstalling MD Storage Manager From Windows

Uninstall MD Storage Manager From Microsoft Windows Operating Systems Other Than Microsoft Windows Server 2008

Use the **Change/Remove Program** feature to uninstall the Modular Disk Storage Manager from Microsoft Windows operating systems other than Microsoft Windows Server 2008. To uninstall the Modular Disk Storage Manager from Microsoft Windows Server 2008:

1. Double-click **Add or Remove Programs** from the **Control Panel**.
2. Select **Dell MD3260** storage software from the list of programs.
3. Click **Change/Remove**.
The **Uninstall Complete** window is displayed.
4. Follow the instructions on screen.
5. Select **Yes** to restart the system, and then click **Done**.

Uninstall MD Storage Manager From Windows Server 2008 GUI Versions

To uninstall Modular Disk Storage Manager from Windows Server 2008 GUI versions:

1. Double-click **Programs and Features** from the **Control Panel**.
2. Select **MD Storage Software** from the list of programs.
3. Click **Uninstall/Change**.
The **Uninstall Complete** window is displayed.
4. Follow the instructions on screen.
5. Select **Yes** to restart the system, then click **Done**.

Uninstall MD Storage Manager From Windows Server 2008 Core Versions

To uninstall PowerVault Modular Disk Storage Manager on Windows Server 2008 Core versions:

1. Navigate to the **Dell\MD Storage Software\Uninstall Dell Modular Disk MD3260 Storage Software** directory.
 **NOTE:** By default, MD Storage Manager is installed in the **\Program Files\Dell\MD Storage Software** directory. If another directory was used during installation, navigate to that directory before beginning the uninstallation procedure.
2. From the installation directory, type the following command and press <Enter>:
`Uninstall Modular Disk Storage`
3. From the **Uninstall** window, click **Next** and follow the instructions on the screen.
4. Select **Yes** to restart the system, then click **Done**.

Uninstalling MD Storage Manager From Linux

By default, PowerVault MD Storage Manager is installed in the `/opt/dell/mdstoragemanager` directory. If another directory was used during installation, navigate to that directory before beginning the uninstallation procedure.

1. From the installation directory, open the **Uninstall Dell MD Storage Software** directory.
2. Run the file **Uninstall Dell MD Storage Software.exe**.
3. From the **Uninstall** window, click **Next**, and follow the instructions on the screen.
While the software is uninstalling, the **Uninstall** window is displayed. When the uninstall procedure is complete, the **Uninstall Complete** window is displayed.
4. Click **Done**.

Appendix — Load Balancing

Windows Load Balance Policy

Multi-path drivers select the I/O path to a virtual disk through a specific RAID controller module. When the multi-path driver receives a new I/O, the driver tries to find a path to the current RAID controller module that owns the virtual disk. If that path cannot be found, the multi-path driver migrates the virtual disk ownership to the secondary RAID controller module. When multiple paths to the RAID controller module that owns the virtual disk exist, you can choose a load balance policy to determine which path is used to process I/O. Multiple options for setting the load balance policies let you optimize I/O performance when mixed host interfaces are configured.

You can choose one of the following load balance policies to optimize I/O performance:

- Round robin with subset
- Least queue depth with subset

Round Robin With Subset

The round-robin with subset I/O load balance policy routes I/O requests, in rotation, to each available data path to the RAID controller module that owns the virtual disks. This policy treats all paths to the RAID controller module that owns the virtual disk equally for I/O activity. Paths to the secondary RAID controller module are ignored until ownership changes. The basic assumption for the round-robin policy is that the data paths are equal. With mixed host support, the data paths may have different bandwidths or different data transfer speeds.

Changing Load Balance Policies In Windows Server 2008

Load balancing with the PowerVault MD3260 series is only available for Windows Server 2008 or later versions of the operating system. You can change the load balance policies from the default round robin with subset by using one of the following:

- Device Manager options
- Disk Management options

Least Queue Depth With Subset

The least queue depth with subset policy is also known as the least I/Os, or least requests policy. This policy routes the next I/O request to a data path that has the least outstanding I/O requests queued. For this policy, an I/O request is simply a command in the queue. The type of command or the number of blocks that are associated with the command are not considered. The least queue depth with subset policy treats large block requests and small block requests equally. The data path selected is in the path group of the RAID controller module that owns the virtual disk.

Changing The Load Balance Policy Using Windows Server 2008 Device Manager Options

1. From the host desktop, right-click **My Computer** and select **Manage**.
The **Computer Management** window is displayed.
2. Click **Device Manager** to show the list of devices attached to the host.
3. Right-click the multi-path disk device for which you want to set load balance policies, then select **Properties**.
4. From the **MPIO** tab, select the load balance policy you want to set for this disk device.

Changing The Load Balance Policy Using The Windows Server 2008 Disk Management Options

1. From the host desktop, right-click **My Computer** and select **Manage**.
The **Computer Management** window is displayed.
2. Click **Disk Management** to show the list of virtual disks attached to the host.
3. Right-click the virtual disk on which you want to set the load balance policy, then click **Properties**.
4. From the **MPIO** tab, select the load balance policy that you want to set for this virtual disk.

Setting Load Balance Policies in Linux

Linux only supports round robin based load balancing. For more information, see [Round Robin With Subset](#).